



**TEREX LIFTING AUSTRALIA PTY LTD**

Curtin Avenue East • P.O. Box 1396 • Eagle Farm QLD 4009 AUSTRALIA  
Telephone: (+61) 7 3868 9600 Facsimile: (+61) 7 3268 2489  
Internet: www.franna.com.au E-Mail: info@franna.com.au

ABN 86 010 671 048  
ACN 010 671 048



# CRANE RATING MANUAL

## MODEL AT-20

BOOK PART NUMBER 16C1320-

# HYDRAULIC ALL TERRAIN PICK & CARRY CRANE

20 TONNE MAXIMUM CAPACITY

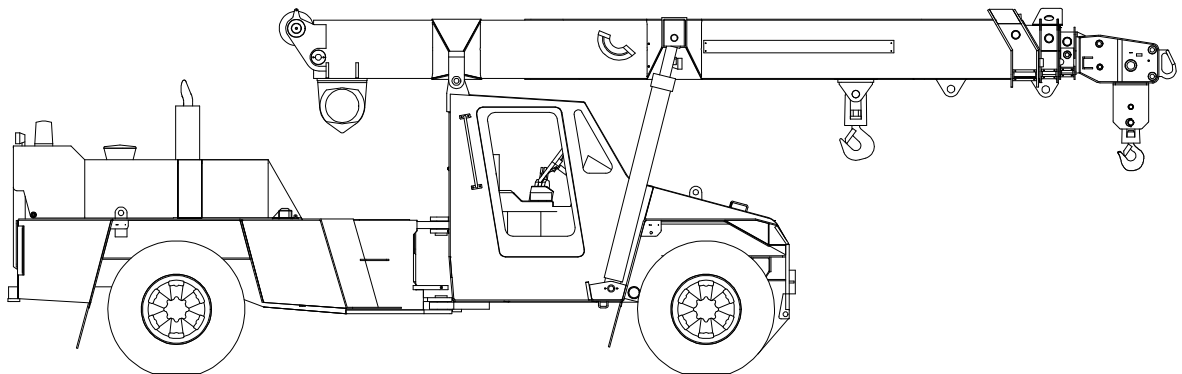

**Do not operate this  
crane unless you have  
read and understood  
the information in this  
book.**

# 16C1320- RATING CHART BOOK AT-20

ALL PAGES LISTED MUST BE INCLUDED IN THIS BOOK.

Page No.	Description
0-1	MODEL NUMBER INDEX  INDEX
0-3	PAGE LIST
0-3	INDEX, GENERAL  SECTION 1 – WARNINGS
1-1	INDEX, SECTION 1
1-2	CAUTION
1-3	DEFINITIONS
1-4	WARNINGS, PAGE 1
1-5	WARNINGS, PAGE 2  SECTION 2 – OPERATION
2-1	INDEX, SECTION 2
2-2	ATTACHMENT NOTICE
2-3	WORKING AREA & RANGE DIAGRAMS
2-4	OPERATION
2-5	WINCH LINE PULL & INFO  SECTION 3 – LIFTING CAPACITY
3-1	LMI CODES
3-2	RANGE DIAGRAM
3-3	LMI DUTY 01 : WINCH - POWERED SECTIONS
3-4	LMI DUTY 03 : WINCH – MANUAL EXTENSION
3-5	LMI DUTY 02 : RHINO HOOK - POWERED SECTIONS
3-6	LMI DUTY 04 : RHINO HOOK – MANUAL EXTENSION
3-7	LMI DUTY 05 & 6 : FLYJIB (0° OFFSET)
3-8	LMI DUTY 07 & 8 : FLYJIB (12.5° OFFSET)
3-9	LMI DUTY 09 : FIXED LUG ON BUTT
3-10	LMI DUTY 10 : INNER LUG ON FIRST EXT.
3-11	LMI DUTY 11 : OUTER LUG ON FIRST EXT.
3-12	LMI DUTY 12 & 13 : MAN BASKET  SECTION 4 – CRANE DATA
4-1	INDEX, SECTION 4
4-3	MACHINE DIMENSIONS
4-4	HYDRAULIC DATA

# GENERAL SUBJECT INDEX

## SECTION 1: WARNINGS

CAUTION NOTE  
DEFINITIONS  
WARNING NOTES

## SECTION 2: OPERATION DATA

ATTACHMENT NOTICE  
RANGE DIAGRAM  
WORK AREAS DIAGRAM  
OPERATIONAL NOTES  
WINCH LINE PULL & ROPE INFORMATION  
TYRE INFORMATION

## SECTION 3: LIFTING CAPACITY

LMI CODES  
RANGE DIAGRAM  
LMI DUTY 01 : WINCH - POWERED SECTIONS  
LMI DUTY 03 : WINCH – MANUAL EXTENSION  
LMI DUTY 02 : RHINO HOOK - POWERED SECTIONS  
LMI DUTY 04 : RHINO HOOK – MANUAL EXTENSION  
LMI DUTY 05 & 6 : FLYJIB (0° OFFSET)  
LMI DUTY 07 & 8 : FLYJIB (12.5° OFFSET)  
LMI DUTY 09 : FIXED LUG ON BUTT  
LMI DUTY 10 : INNER LUG ON FIRST EXT.  
LMI DUTY 11 : OUTER LUG ON FIRST EXT.  
LMI DUTY 12 & 13 : MAN BASKET

## SECTION 4 – CRANE DATA

MACHINE DIMENSIONS  
HYDRAULIC DATA

# **SECTION 1**

# **WARNINGS**

CAUTION NOTE

DEFINITIONS

WARNINGS

# **! CAUTION !**

**IMPROPER CRANE USE, CARE OR OPERATION CAN CAUSE INJURY, DEATH OR PROPERTY DAMAGE.**

**DO NOT OPERATE THIS MACHINE UNLESS YOU HAVE READ AND UNDERSTAND THE OPERATOR'S MANUAL, SAFE OPERATING PRACTICES BOOKLET AND CRANE RATING MANUAL.**

**COPIES OF OPERATOR'S MANUALS, SAFE OPERATING PRACTICES BOOKLET AND CRANE RATING MANUAL MAY BE OBTAINED FROM:**



**TEREX LIFTING  
AUSTRALIA PTY LTD**

# DEFINITIONS

**Articulation** – The crane pivots in the middle to allow steering and slewing the load. Working areas for the purpose of load rating are less than 10° articulation either way and greater than 10° (up to 40° articulation is possible either way). *see working area diagram*

**Freely Suspended Load** – Load hanging free with no direct external force applied except by the hoist line.

**Load Radius** – Horizontal distance from the centre of the front wheels forwards to the centre of the hoist line or tackle with load applied.

**Loaded Boom Angle** – This is given to assist in setting up the crane only. It gives only an approximation of the radius for a specified boom length. No allowance is made for boom or tyre deflection. The ratings are for the boom length and Load Radius shown.

**Rated Lifting Capacity** – The total suspended load, including the weight of material and load handling equipment, that the machine can safely lift under ideal conditions at a given boom length and load radius.

**Side Load** – Any external force applied either to the boom or load in a horizontal direction.

**Work Areas** – Area measured in an arc about the centre pivot as shown on the working area diagram. Lamps on the dash indicate which zone the crane is in.

# ! WARNING !

## SPECIAL PRECAUTIONS FOR ARTICULATED CRANES

THERE IS A POTENTIAL FOR CRUSHING BETWEEN FRONT AND REAR CHASSIS WHEN THE MACHINE ARTICULATES. NEVER STAND IN THE PIVOT AREA WHEN THE ENGINE IS RUNNING OR EMERGENCY STEERING PUMP IS OPERATING. ALWAYS REMOVE THE KEY FROM THE IGNITION BEFORE WORKING IN THE PIVOT AREA. DO NOT LEAVE IGNITION KEY SWITCHED ON WITH ENGINE STOPPED AND PARK BRAKE OFF, AS EMERGENCY HYDRAULIC STEERING PUMP WILL ACTIVATE.

## GENERAL

1. This machine has been designed to meet the requirements of AS1418.1 & 1418.5 and has been tested in accordance with these standards for pick and carry operation on tyres.
2. Rated lifting capacities shown are for this machine as originally manufactured by Terex Lifting Australia Pty Ltd. The lifting capacities only apply when all the instructions in this book are rigidly followed. Modifications to this machine or use of equipment other than that specified can result in a reduction of capacity.
3. If improperly operated or maintained, this machine can be hazardous. Operation and maintenance of this machine must be in compliance with the information in the operators, service, parts and safety manuals furnished. If these manuals are missing, obtain replacements through Terex Lifting Australia Pty Ltd or their agents.

## SET-UP

4. Reduced crane lifting capacities for the particular job shall be established by the user with due allowance for adverse operating conditions. These conditions include the supporting surface, pendulum action of the load, jerking or sudden stops of the load and other factors affecting stability, two machine lifts, electrical wires, adverse weather, wind, hazardous surroundings, experience of personnel, etc.
5. Rated lifting capacities are based on freely suspended loads with the machine on a firm, level (max. 1% slope / 0.6°) and uniform surface. Lifting or travelling with a load on soft or uneven ground can be hazardous and will reduce the capacity of the crane. No attempt shall be made to drag the load along the ground in any direction.

# ! WARNING !

6. Rated lifting capacities above the red line are based on the machine's hydraulic or structural competence and not on machine stability. Rated capacities below the red line are based on machine stability.
7. The Rated lifting capacities include the weight of hooks, blocks, slings and auxiliary lifting devices. Their weight must be subtracted from the listed rating to determine the net load that can be lifted.
8. Loaded boom angles at specified boom lengths give only an approximation of the operating radius. The boom angle before loading should be greater to account for boom deflection increasing the radius as the load is lifted.

## OPERATION

9. Side loading of the machine and load swing out may cause structural failure or machine tip-over. Side loads may be generated by: lifting when not level; sudden acceleration or deceleration in articulating with a load; dragging a load; pushing a load; wind forces on load and boom structure.
10. The capacity of the manual extension is structurally limited. The boom may be retracted and extended with the manual set, however the rating does not change from the fully extended position for the given boom angle.
11. It is safe to attempt to telescope any load within the limits of the rating chart. The maximum load that may be telescoped is limited by hydraulic pressure, boom angle and powered boom sections lubrication.
12. Do not allow the winch rope to unwind fully. Always ensure a minimum of two (2) wraps of rope remain on the winch drum. Note the areas on the range diagram where the fall block cannot reach the ground on four (4) or three (3) parts of rope.
13. Crane lifting capacities on tyres depend on tyre capacity, condition of the tyres and tyre air pressure. Tyres must be inflated to the recommended pressure before lifting.
14. Pick & carry operation is permitted through the full articulation range, however capacity is reduced above 10° articulation. Use the reduced ratings in the chart if entering this articulation range during the operation.
15. The maximum speed for pick & carry operation is 0.4m/s (1.6km/h). The transmission shall be set to low range.
16. Operation of this crane in excess of rating configuration charts and disregard of the instructions is hazardous.



# **SECTION 2**

# **OPERATIONS**

ATTACHMENT NOTICE

WORKING AREAS & RANGE DIAGRAM

OPERATION (ON TYRES)

WEIGHT OF HOOKS

WINCH LINE PULL

TYRE INFLATION PRESSURES

# **NOTICE**

**WRITTEN AUTHORISATION IS REQUIRED  
FROM TEREX LIFTING AUSTRALIA PTY LTD  
PRIOR TO THE USE OF ANY ATTACHMENT  
NOT SPECIFIED IN THE MANUAL.**

# RANGE DIAGRAM AT-20 SHOWING ALL LIFTING CONFIGURATIONS

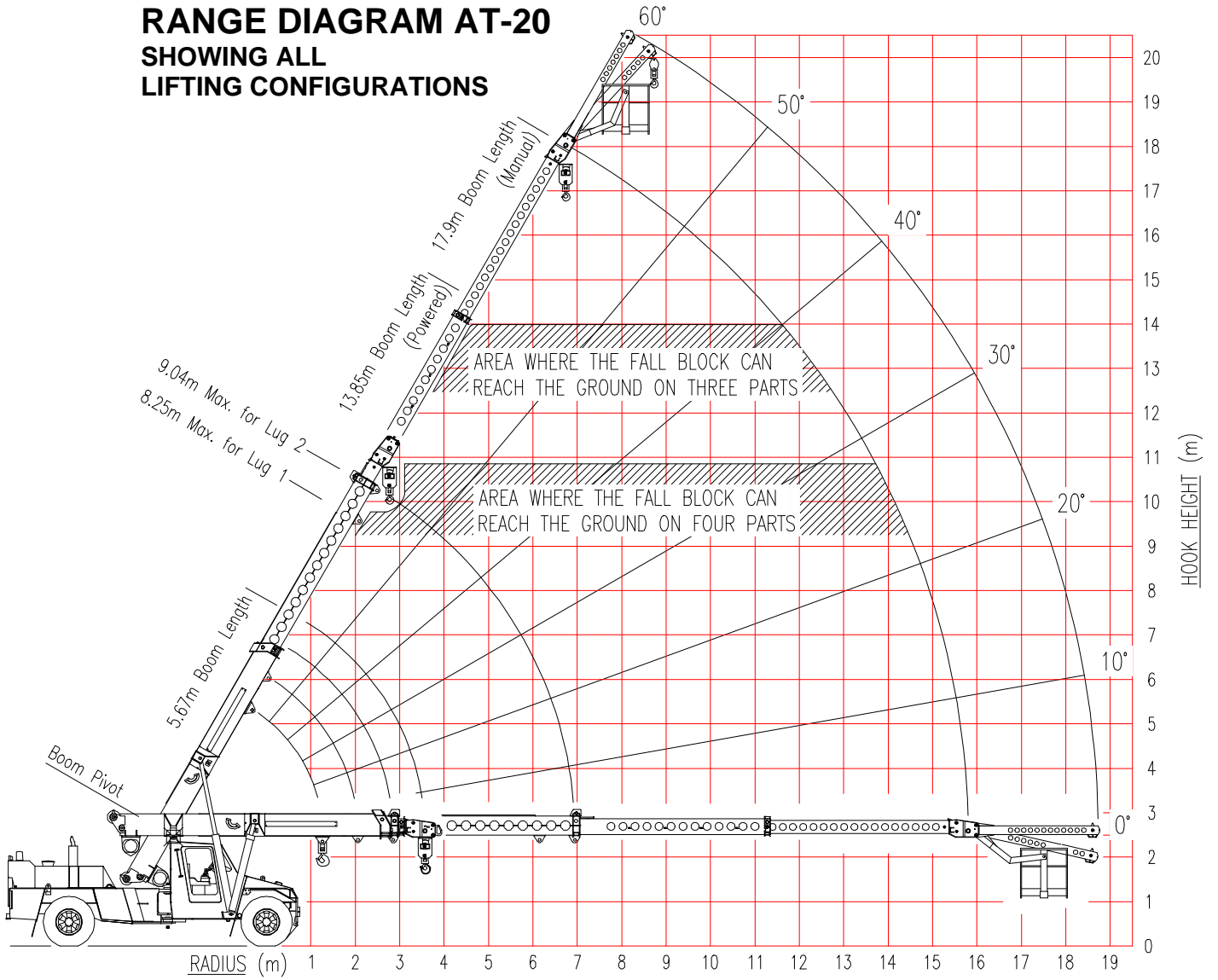

## Working Area Diagram

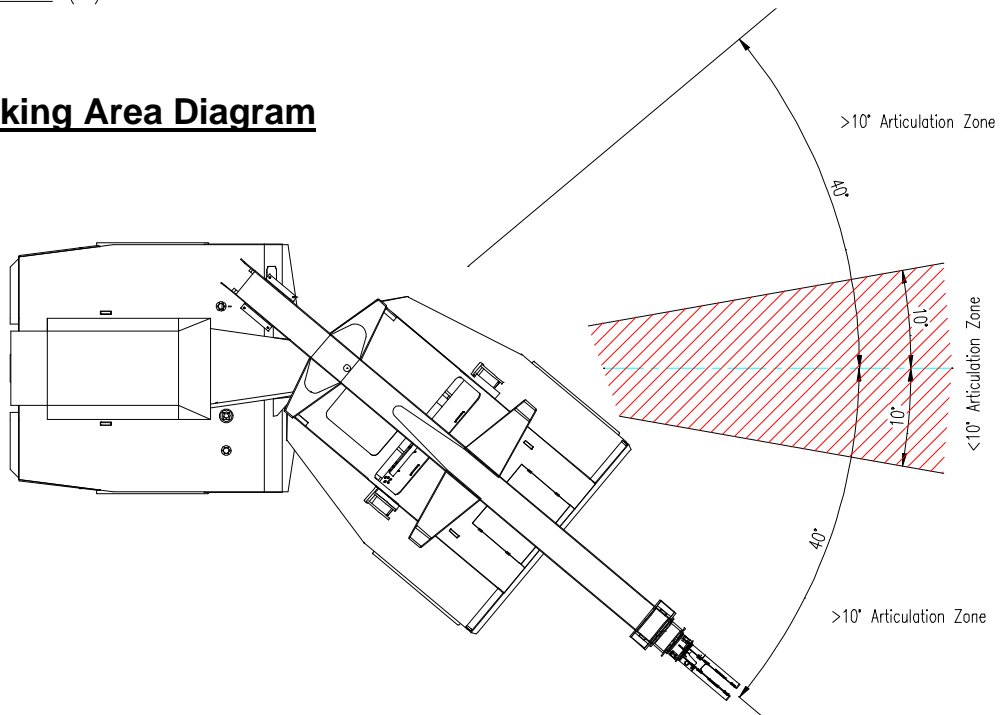

# OPERATION

1. Read and understand all warnings and instructional notes.
2. Rated lifting capacities above the red line are based on the machine's hydraulic or structural competence and not on machine stability. Rated capacities below the red line are based on machine stability.
3. Do not tip the machine to determine allowable lifting capacities.
4. The Rated lifting capacities include the weight of hooks, blocks, slings and auxiliary lifting devices. Their weight must be subtracted from the listed rating to determine the net load that can be lifted.
5. Crane lifting capacities on tyres depend on tyre capacity, condition of the tyres and tyre air pressure. Tyres must be inflated to the recommended pressure before lifting.
6. Pick & carry operation is permitted through the full articulation range, however capacity is reduced above 10° articulation. Use the reduced ratings in the chart if entering this articulation range during the operation.
7. Loads may be lifted from the main boom head on the winch or the rhino hook, the fixed lug, or either of the two sliding lugs on the boom. A flyjib is also available to extend the maximum boom length and a manbasket can be pinned to the head of the boom. Always use the correct rating chart for the lifting point in use and ensure the LMI is set to the correct duty.
8. Lifting from more than one lifting point simultaneously is neither intended nor approved.
9. When either the boom length or radius or both are between values listed, the smallest load shown at either the next larger radius or boom length shall be used, or the interpolated value shown on the LMI may be used
10. The winch rope is fully compensated for boom extension. The only exception is when the manual extension is being set. Refer to the operator's manual for the manual setting procedure. Once it is set the compensation is fully functional.
11. The maximum speed for pick & carry operation is 0.4m/s (1.6km/h). The transmission shall be set to low range.
12. Handling of personnel from the boom is neither intended nor approved, except in a Terex Lifting Australia supplied manbasket, correctly installed on the head of the boom, or other approved arrangement.

## HOOK BLOCK WEIGHTS

<b>SINGLE PART HOOK BLOCK</b>	<b>30 kg</b>
<b>TWO/THREE PART HOOK BLOCK</b>	<b>95 kg</b>
<b>FOUR PART HOOK BLOCK</b>	<b>125 kg</b>
<b>20 METRIC TONNE HOOK</b>	<b>15 kg</b>

**NOTE : THESE WEIGHTS APPLY ONLY TO TEREX LIFTING AUSTRALIA PTY LTD SUPPLIED EQUIPMENT.**

## WINCH LOAD CHART

Number of Parts of Rope	Permissible Winch Load (kg)
<b>1</b>	<b>4 200</b>
<b>2</b>	<b>8 400</b>
<b>3</b>	<b>12 600</b>
<b>4</b>	<b>16 800</b>

**Wire Rope : 14mm 35W x 7 Non-rotating Compak  
Minimum Breaking Force 165 kN**

## TYRE INFLATION CHART

Position	Construction & Ply Rating	Inflation Pressure - PSI	
		Pick & Carry	Highway Travel
Front	12.00 – 20 x 20 Ply	125	125
Rear	12.00 – 20 x 20 Ply	90	90

# SECTION 3

## LIFTING CAPACITY

RANGE DIAGRAM (ALL LIFTS)

LMI DUTY 01 : LIFTING CAPACITY ON WINCH -POWERED SECTIONS

LMI DUTY 03 : LIFTING CAPACITY ON WINCH –MANUAL EXTENSION

LMI DUTY 02 : LIFTING CAPACITY ON RHINO HOOK -POWERED SECTIONS

LMI DUTY 04 : LIFTING CAPACITY ON RHINO HOOK – MANUAL EXTENSION

LMI DUTY 05 : LIFTING CAPACITY ON FLYJIB (0° OFFSET) - POWERED SECTIONS

LMI DUTY 06 : LIFTING CAPACITY ON FLYJIB (0° OFFSET) - MANUAL EXTENSION

LMI DUTY 07 : LIFTING CAPACITY ON FLYJIB (12.5° OFFSET) - POWERED SECTIONS

LMI DUTY 08 : LIFTING CAPACITY ON FLYJIB (12.5° OFFSET) - MANUAL EXTENSION

LMI DUTY 09 : LIFTING CAPACITY ON FIXED LUG ON BUTT

LMI DUTY 10 : LIFTING CAPACITY ON INNER LUG ON FIRST EXT.

LMI DUTY 11 : LIFTING CAPACITY ON OUTER LUG ON FIRST EXT.

LMI DUTY 12 : LIFTING CAPACITY IN MAN BASKET – POWERED SECTIONS

LMI DUTY 13 : LIFTING CAPACITY IN MAN BASKET – MANUAL EXTENSION

# RANGE DIAGRAM AT-20

## SHOWING ALL LIFT CONFIGURATIONS

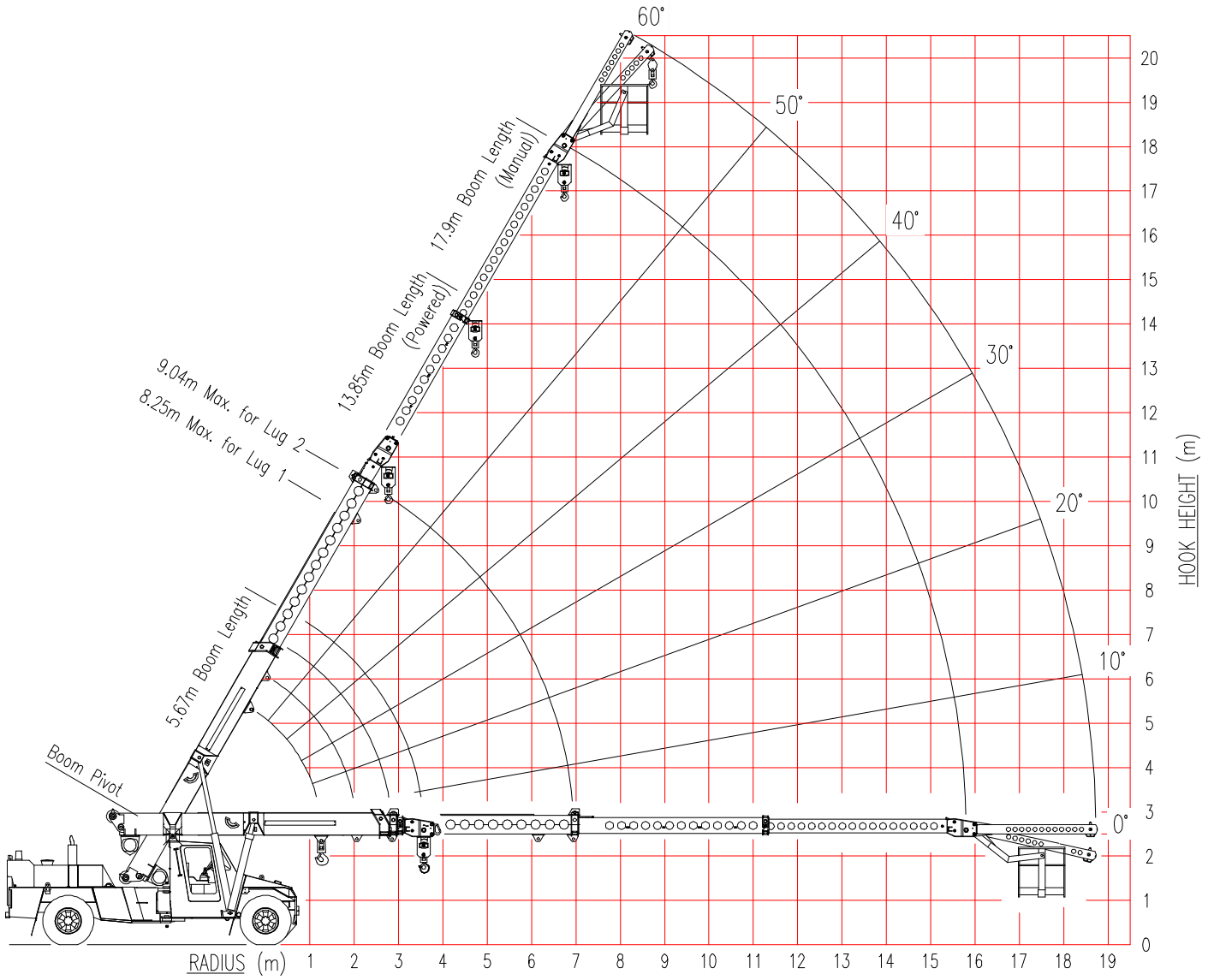

16C1320-/3-3

RADIUS	BOOM LENGTH (m)																	
	5.67	6.00	6.50	7.00	7.50	8.00	8.50	9.00	9.50	10.00	10.50	11.00	11.50	12.00	12.50	13.00	13.50	13.85
1.6	16800	16250	15450	14900														
	12600	12600	12600	12600														
2.0	48	51	54	57														
	16800	16800	16500	15700	15100	14700	14350											
2.5	12600	12600	12600	12600	12600	12600	12600	12600										
	42	46	50	53	56	58	60											
3.0	13900	13900	13900	13850	13850	13850	13850	13200	13000									
	12150	12150	12100	12100	12100	12100	12100	12050	12050									
3.5	34	39	44	48	51	54	56	58	60									
	11450	11450	11450	11400	11400	11400	11400	11400	11400	11150	10250							
4.0	9950	9950	9950	9950	9950	9950	9900	9900	9900	9900	9900							
	25	31	37	42	46	49	52	55	57	59	60							
4.5	9650	9650	9650	9650	9650	9650	9650	9650	9650	9650	9650	9500	8150	7500				
	8400	8400	8400	8400	8400	8400	8400	8400	8350	8350	8350	8350	8150	7500				
5.0	8	20	29	36	41	45	48	51	53	55	57	59	60					
	9450	8550	8350	8350	8350	8350	8350	8350	8300	8300	8300	8300	7600	7000	6700	6450		
5.5	8200	7450	7250	7250	7250	7250	7250	7200	7200	7200	7200	7200	7200	7000	6700	6450		
	(3.57)	(3.90)	19	28	35	39	43	47	49	52	54	56	57	59	60			
6.0			7500	7300	7300	7300	7300	7300	7300	7300	7300	7150	6550	6250	6050	5800	5650	
			6500	6350	6350	6350	6350	6350	6300	6300	6300	6300	6300	6300	6250	6050	5800	5650
6.5			(4.40)	19	27	34	38	42	45	48	50	52	54	56	58	59	60	
			6650	6500	6500	6500	6500	6500	6500	6500	6500	6500	6150	5900	5650	5450	5300	5150
7.0			5750	5600	5600	5600	5600	5600	5600	5600	5600	5600	5600	5600	5600	5450	5300	5150
			(4.90)	18	27	33	37	41	44	47	49	49	51	53	55	56	58	59
7.5			5950	5350	5250	5250	5250	5250	5250	5250	5250	5250	5250	5250	5050	4850	4700	4600
			5100	4600	4550	4550	4550	4550	4500	4500	4500	4500	4500	4500	4500	4500	4500	4500
8.0			(5.40)	(5.90)	17	25	31	35	39	42	45	47	49	51	53	54	54	
			4850	4450	4400	4400	4400	4400	4400	4400	4400	4400	4350	4350	4350	4200	3950	
8.5			4200	3800	3750	3750	3750	3750	3750	3750	3750	3750	3750	3750	3750	3750	3750	
			(6.40)	(6.90)	16	24	29	34	37	40	43	45	47	48				
9.0			4100	3750	3700	3700	3700	3700	3700	3700	3700	3700	3700	3700	3700	3700	3600	
			3500	3200	3150	3150	3150	3150	3150	3150	3150	3150	3150	3150	3150	3150	3150	3150
9.5			(7.40)	(7.90)	15	23	28	32	36	38	41	43						
			3500	3250	3200	3200	3200	3200	3200	3200	3200	3200	3200	3200	3200	3200	3200	3200
10.0			2950	2750	2700	2700	2700	2700	2700	2700	2700	2700	2700	2700	2700	2700	2700	2700
			(8.40)	(8.90)	15	22	27	31	34	36	38	41	43					
10.5			3000	2800	2800	2800	2800	2800	2800	2800	2800	2800	2800	2800	2800	2800	2800	2800
			2550	2400	2350	2350	2350	2350	2350	2350	2350	2350	2350	2350	2350	2350	2350	2350
11.0			(9.40)	(9.90)	14	21	26	29										
			2650	2500	2450	2450	2450	2450	2450	2450	2450	2450	2450	2450	2450	2450	2450	2450
11.5			2200	2100	2050	2050	2050	2050	2050	2050	2050	2050	2050	2050	2050	2050	2050	2050
			(10.40)	(10.90)	13	18												
11.75			2350	2250	2250	2250	2250	2250	2250	2250	2250	2250	2250	2250	2250	2250	2250	2250
			1950	1850	1850	1850	1850	1850	1850	1850	1850	1850	1850	1850	1850	1850	1850	1850
			(11.40)	(11.75)														



SWL (KG) LESS THAN 10 DEG ARTICULATION  
 SWL (KG) GREATER THAN 10 DEG ARTICULATION  
 BOOM ANGLE OR (RADIUS AT 0 DEG BOOM ANGLE)

Weight of slings & hook block to be added to load  
 Read and understand warning notes before operating crane  
 Loads above bold red line are structural

LMI Duty  
 Lifting on WINCH  
 01



	SWL (KG) LESS THAN 10 DEG ARTICULATION
	SWL (KG) GREATER THAN 10 DEG ARTICULATION
	BOOM ANGLE

*Weight of slings & hook block to be added to load  
 Read and understand warning notes before operating crane  
 Loads above bold red line are structural*

MANUAL EXT'N	
MAX LENGTH 17.90	
MAX RADIUS	SWL
6.74	2550
	2550
9.31	60
	2250
	2250
11.53	50
	2050
	2050
13.34	40
	1900
	1700
14.67	30
	1800
	1500
15.51	20
	1650
	1350
15.80	10
	1600
	1300
	0

**NOTE :**  
 17.9m Boom length includes Manual 3rd extension.  
 Ratings for Manual extension are structural & based on Boom Angle, not radius. The ratings do not change if the power sections are retracted with the manual extended.

RADIUS	BOOM LENGTH (m)																		
	5.97	6.50	7.00	7.50	8.00	8.50	9.00	9.50	10.00	10.50	11.00	11.50	12.00	12.50	13.00	13.50	14.00	14.16	
1.6	10000	10000	10000	10000															
	51	54	57	60															
2.0	10000	10000	10000	10000	10000	10000													
	46	50	53	56	58	60													
2.5	10000	10000	10000	10000	10000	10000	10000	10000											
	39	44	48	51	54	57	59	60											
3.0	10000	10000	10000	10000	10000	10000	10000	10000	10000	10000									
	30	37	42	46	50	52	55	57	59	60									
3.5	9750	9750	9750	9700	9700	9700	9700	9700	9700	9650	8850	7650							
	19	30	36	41	45	48	51	53	55	57	59	60							
4.0	8700	8400	8400	8400	8400	8400	8400	8350	8350	8350	8100	7100	6750	6500					
	7550	7300	7300	7300	7300	7300	7300	7250	7250	7250	7250	7100	6750	6500					
4.5	(3.88)	19	29	35	40	43	47	49	52	54	56	57	59	60					
	7550	7400	7400	7350	7350	7350	7350	7350	7350	7350	7350	6650	6300	6100	5850	5700			
5.0	(4.40)	19	28	34	38	42	45	48	50	53	54	56	58	59	60				
	6700	6550	6550	6550	6550	6550	6550	6550	6550	6500	6500	6250	5950	5700	5500	5350	5150	5100	
6.0	(4.90)	18	27	33	37	41	44	47	49	49	51	53	55	56	58	59	59		
	6000	5400	5300	5300	5300	5300	5300	5300	5300	5300	5300	5300	5100	4900	4750	4600	4550		
7.0	(5.40)	(5.90)	17	25	31	35	39	42	45	47	49	51	53	55	56	58	59	59	
	4900	4500	4400	4400	4400	4400	4400	4400	4400	4400	4400	4400	4400	4400	4400	4250	4000	3950	
8.0	(6.40)	(6.90)	16	24	29	34	37	40	43	45	47	49	51	53	55	56	58	59	59
	4200	3850	3800	3800	3800	3800	3800	3800	3800	3800	3800	3800	3750	3750	3750	3750	3750	3750	3750
9.0	(7.40)	(7.90)	15	23	28	32	36	39	41	43	45	47	49	51	53	55	56	58	59
	4100	3800	3750	3750	3750	3750	3750	3750	3750	3750	3750	3750	3750	3750	3750	3750	3750	3600	3550
10.0	(8.40)	(8.90)	15	22	27	31	34	37	40	43	45	47	49	51	53	55	56	58	59
	3500	3250	3250	3250	3250	3250	3250	3250	3250	3250	3250	3250	3250	3250	3250	3250	3250	3250	3250
11.0	(9.40)	(9.90)	15	22	27	31	34	37	40	43	45	47	49	51	53	55	56	58	59
	3000	2800	2750	2750	2750	2750	2750	2750	2750	2750	2750	2750	2750	2750	2750	2750	2750	2750	2750
12.00	(10.40)	(10.90)	14	21	26	30	31												
	3050	2850	2800	2800	2800	2800	2800	2800	2800	2800	2800	2800	2800	2800	2800	2800	2800	2800	2800
	(11.40)	(11.90)	(12.00)																



SWL (KG) LESS THAN 10 DEG ARTICULATION  
 SWL (KG) GREATER THAN 10 DEG ARTICULATION  
 BOOM ANGLE OR (RADIUS AT 0 DEG BOOM ANGLE)

Weight of slings & hook block to be added to load  
 Read and understand warning notes before operating crane  
 Loads above bold red line are structural

LMI Duty  
 Lifting on RHINO HOOK  
**02**

	SWL (KG) LESS THAN 10 DEG ARTICULATION
	SWL (KG) GREATER THAN 10 DEG ARTICULATION
	BOOM ANGLE

*Weight of slings & hook block to be added to load*  
*Read and understand warning notes before operating crane*  
*Loads above bold red line are structural*



MANUAL EXT'N	
MAX LENGTH 18.20	
MAX RADIUS	SWL
<b>6.91</b>	<b>2400</b>
	<b>2400</b>
<b>9.52</b>	60
	<b>2100</b>
	<b>2100</b>
<b>11.78</b>	50
	<b>1900</b>
	<b>1900</b>
<b>13.62</b>	40
	<b>1800</b>
	<b>1650</b>
	30
<b>14.97</b>	<b>1750</b>
	<b>1450</b>
	20
<b>15.81</b>	<b>1550</b>
	<b>1350</b>
	10
<b>16.11</b>	<b>1550</b>
	<b>1300</b>
	0

**NOTE :**  
 18.2m Boom length includes Manual 3rd extension.  
 Ratings for Manual extension are structural & based on Boom Angle, not radius. The ratings do not change if the power sections are retracted with the manual extended.

**LMI Duty**  
Lifting on FLYJIB (0 offset)

**05**

FLYJIB	
MAX LENGTH 16.78	
MAX RADIUS	SWL
6.23	1500
	60
8.62	1200
	1200
	50
10.69	970
	970
	40
12.37	850
	850
	30
13.62	770
	770
	20
14.40	750
	750
	10
14.68	750
	750
	0

 SWL (KG) LESS THAN 10 DEG ARTICULATION  
 SWL (KG) GREATER THAN 10 DEG ARTICULATION  
 BOOM ANGLE



*Weight of slings & hook block to be added to load  
Read and understand warning notes before  
operating crane  
Loads above bold red line are structural*

**NOTE :**  
16.78m Boom length includes Flyjib.  
Ratings for Flyjib are structural & based  
on Boom Angle, not radius. The ratings do not  
change if the power sections are retracted with  
the Flyjib installed

**LMI Duty**  
Lifting on FLYJIB (0 offset)

**06**

MANUAL EXT'N	
MAX LENGTH 20.83	
MAX RADIUS	SWL
8.25	1500
	60
11.22	1200
	1200
	50
13.79	970
	970
	40
15.88	850
	850
	30
17.43	770
	770
	20
18.39	750
	750
	10
18.73	750
	750
	0

 SWL (KG) LESS THAN 10 DEG ARTICULATION  
 SWL (KG) GREATER THAN 10 DEG ARTICULATION  
 BOOM ANGLE



*Weight of slings & hook block to be added to load  
Read and understand warning notes before  
operating crane  
Loads above bold red line are structural*

**NOTE :**  
20.83m Boom length includes Manual 3rd extension  
& Flyjib. Ratings for Flyjib are structural & based  
on Boom Angle, not radius. The ratings do not  
change if the power sections are retracted with  
the manual extended.

**LMI Duty**  
**Lifting on FLYJIB**  
**(12.5 deg offset)**

**07**

FLYJIB	
MAX LENGTH 16.71	
MAX RADIUS	SWL
6.71	1500
	60
9.04	1200
	1200
	50
11.03	970
	970
	40
12.63	850
	850
	30
13.78	770
	770
	20
14.46	750
	750
	10
14.64	750
	750
	0

 SWL (KG) LESS THAN 10 DEG ARTICULATION  
 SWL (KG) GREATER THAN 10 DEG ARTICULATION  
 BOOM ANGLE



*Weight of slings & hook block to be added to load  
 Read and understand warning notes before  
 operating crane  
 Loads above bold red line are structural*

**NOTE :**  
 16.71m Boom length includes Flyjib.  
 Ratings for Flyjib are structural & based  
 on Boom Angle, not radius. The ratings do not  
 change if the power sections are retracted with  
 the Flyjib installed

**LMI Duty**  
**Lifting on FLYJIB**  
**(12.5 deg offset)**

**08**

MANUAL EXT'N	
MAX LENGTH 20.76	
MAX RADIUS	SWL
8.73	1300
	60
11.64	1120
	1120
	50
14.13	920
	920
	40
16.14	820
	820
	30
17.59	770
	770
	20
18.45	750
	750
	10
18.69	750
	750
	0

 SWL (KG) LESS THAN 10 DEG ARTICULATION  
 SWL (KG) GREATER THAN 10 DEG ARTICULATION  
 BOOM ANGLE

*Weight of slings & hook block to be added to load  
 Read and understand warning notes before  
 operating crane  
 Loads above bold red line are structural*

**NOTE :**  
 20.76m Boom length includes Manual 3rd extension  
 & Flyjib. Ratings for Flyjib are structural & based  
 on Boom Angle, not radius. The ratings do not  
 change if the power sections are retracted with  
 the manual extended.



**LMI Duty**  
Lifting on INNER LUG

*Weight of slings & hook block to be added to load  
Read and understand warning notes before operating crane  
Loads above bold red line are structural*

	SWL (KG) LESS THAN 10 DEG ARTICULATION
	SWL (KG) GREATER THAN 10 DEG ARTICULATION
	BOOM ANGLE OR (RADIUS AT 0 DEG BOOM ANGLE)

RADIUS	BOOM LENGTH (m)								
	4.16	4.50	5.00	5.50	6.00	6.50	7.00	7.50	8.25
1.4	20000	20000	20000	19300	18100	17200			
	16000	16000	16000	16000	16000	16000			
	34	40	46	51	55	58			
1.7	19000	19000	19000	18700	17600	16500	15600	15000	
	16000	16000	16000	16000	16000	16000	15600	15000	
	25	33	41	47	51	55	58	60	
2.0	16950	16900	16800	16700	16650	16000	14650	14100	
	14750	14700	14600	14500	14400	14350	14300	14100	
	11	25	36	43	48	52	55	57	
2.5	16400	13800	13150	13100	13050	12950	12900	12750	11350
	14300	11950	11400	11350	11250	11200	11150	11100	11050
	(2.06)	(2.40)	24	34	41	46	50	53	57
3.0			11100	10700	10650	10600	10550	10500	10450
			9600	9200	9150	9100	9050	9000	8950
			(2.90)	23	33	39	44	48	52
3.5				9200	8900	8850	8800	8800	8750
				7900	7650	7600	7550	7500	7450
				(3.40)	22	31	38	42	48
4.0					7800	7550	7550	7500	7450
					6700	6450	6450	6400	6350
					(3.90)	21	30	36	43
4.5						6700	6550	6500	6450
						5700	5550	5500	5500
						(4.40)	20	29	37
5.0							5850	5700	5650
							4950	4800	4800
							(4.90)	19	31
5.5								5150	5000
								4350	4200
								(5.40)	23
6.0									4450
									3700
									11
6.15									4300
									3600
									(6.15)

# LMI Duty

## Lifting on OUTER LUG

*Weight of slings & hook block to be added to load  
Read and understand warning notes before operating crane  
Loads above bold red line are structural*

	SWL (KG) LESS THAN 10 DEG ARTICULATION
	SWL (KG) GREATER THAN 10 DEG ARTICULATION
	BOOM ANGLE OR (RADIUS AT 0 DEG BOOM ANGLE)



RADIUS	BOOM LENGTH (m) - READ OFF SCALE FOR INNER LUG								
	4.16	4.50	5.00	5.50	6.00	6.50	7.00	7.50	8.25
1.4	20000	20000	20000	19900					
	16000	16000	16000	16000					
	46	50	54	57					
1.7	19000	19000	19000	18850	17400	15650			
	16000	16000	16000	16000	16000	15650			
	41	45	50	54	57	59			
2.0	17400	17300	17150	17050	16350	14700	13400		
	15200	15100	14950	14850	14750	14650	13400		
	35	40	46	50	54	56	59		
2.5	13700	13600	13500	13400	13300	13250	12350	11150	10150
	11950	11850	11750	11650	11550	11500	11400	11150	10150
	23	31	38	44	48	52	54	57	60
3.0	11850	11150	11050	11000	10900	10850	10750	10300	9350
	10300	9700	9600	9500	9450	9350	9300	9250	9150
	(2.85)	17	29	37	42	46	50	53	56
3.5		10350	9300	9250	9150	9100	9050	9000	8650
		9000	8050	8000	7900	7850	7800	7750	7650
		(3.20)	16	28	35	41	45	48	52
4.0			8700	7900	7850	7800	7750	7700	7650
			7550	6800	6750	6700	6650	6600	6550
			(3.70)	15	27	34	39	43	48
4.5				7450	6850	6800	6750	6700	6650
				6400	5850	5800	5750	5750	5650
				(4.20)	15	26	33	38	44
5.0					6500	6000	5950	5900	5850
					5550	5100	5050	5000	4950
					(4.70)	14	25	32	39
5.5						5700	5250	5250	5200
						4850	4450	4450	4400
						(5.20)	14	24	33
6.0							5050	4700	4650
							4250	3950	3900
							(5.70)	13	27
6.5								4500	4200
								3750	3500
								(6.20)	19
6.9									3800
									3150
									(6.94)



**LMI Duty**  
Lifting in MANBASKET

**12**

MANBASKET	
MAX LENGTH 13.85	
MAX RADIUS	SWL
<b>6.18</b>	250
	<b>250</b>
	60
8.36	250
	<b>250</b>
	50
10.22	250
	<b>250</b>
	40
11.71	250
	<b>250</b>
	30
12.79	250
	<b>250</b>
	20
13.42	250
	<b>250</b>
	10
13.58	250
	<b>250</b>
	0

 SWL (KG) LESS THAN 10 DEG ARTICULATION  
 SWL (KG) GREATER THAN 10 DEG ARTICULATION  
 BOOM ANGLE



*Read and understand warning notes before operating crane*  
*Loads above bold red line are structural*

**NOTE :**  
13.85m Boom length does not include Manbasket. Ratings for Manbasket are structural & based on Boom Angle, not radius. The ratings do not change if the power sections are retracted with the Manbasket installed

**LMI Duty**  
Lifting in MANBASKET

**13**

MANUAL EXT'N	
MAX LENGTH 17.90	
MAX RADIUS	SWL
<b>8.20</b>	250
	<b>250</b>
	60
10.96	250
	<b>250</b>
	50
13.32	250
	<b>250</b>
	40
15.22	250
	<b>250</b>
	30
16.59	250
	<b>250</b>
	20
17.41	250
	<b>250</b>
	10
17.63	250
	<b>250</b>
	0

 SWL (KG) LESS THAN 10 DEG ARTICULATION  
 SWL (KG) GREATER THAN 10 DEG ARTICULATION  
 BOOM ANGLE

*Read and understand warning notes before operating crane*  
*Loads above bold red line are structural*

**NOTE :**  
17.90m Boom length includes Manual 3rd extension but not Manbasket. Ratings for Manbasket are structural & based on Boom Angle, not radius. The ratings do not change if the power sections are retracted with the manual extended.

# **SECTION 4**

# **CRANE DATA**

MACHINE DIMENSIONS

HYDRAULIC DATA



# HYDRAULIC DATA

MACHINE IS DESIGNED TO OPERATE AT THESE  
MAXIMUM PRESSURES.

<b>FUNCTION</b>	<b>PUMP STANDBY PRESSURE</b>	<b>PUMP PRESSURE COMPEN- SATOR</b>	<b>STEERING RELIEF</b>	<b>TELE PORT RELIEF</b>
<b>SETTING (BAR)</b>	<b>30</b>	<b>220</b>	<b>175</b>	<b>210</b>
<b>TEST POINT</b>	<b>G1</b>	<b>G1</b>	<b>G2</b>	<b>G3</b>

**HYDRAULIC OIL TEMPERATURE MUST BE BETWEEN PLUS 20°C AND  
40°C WHEN SETTING ABOVE PRESSURES.**

**PRESSURES TO BE CHECKED AT 1000 RPM – STANDBY PRESSURE  
CAN BE CHECKED AT IDLE.**

**DO NOT HOLD ON RELIEF MORE THAN 10 SECONDS TO AVOID  
OVERHEATING THE OIL AND HYDRAULIC COMPONENT DAMAGE.**

**UNAUTHORISED PRESSURE SETTINGS IN EXCESS OF THE ABOVE  
VALUES WILL RESULT IN DENIAL OF WARRANTY CLAIMS.**

**PRESSURES TO BE WITHIN 5 BAR OF THE ABOVE VALUES.**